

FUNKIA EVO

Shower cabin with tray, half round

Product code: KYPPN099P

EAN: 5908322032080

Color: nero

Warranty [years]: 5

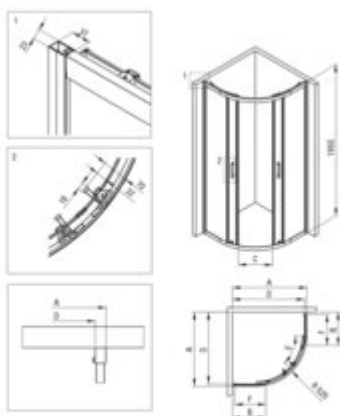

Model	Size	A [mm]	B [mm]	C [mm]	D [mm]	E [mm]	F [mm]
KYP_099P	900x900	900-900	261	120	910	175	325

Showe cabin

Finish	nero
Shape	half round
Width [mm]	900
Height [mm]	1950
Glass finish	transparent
Glass thickness [mm]	5
Active cover	yes
Adjustment range up to [mm]	20
Masking of assembly elements	yes
Profiles levelling the curvature of the walls	yes
Reversible doors	yes
Installation without shower tray possible	yes
Double top rollers with ball bearings	yes
Detachable lower rollers	yes
Quick assembly with clips	yes

Shower tray

Finish	white
Material	acrylic
Shape	half round
Width [mm]	900
Length [mm]	900
Height [mm]	45
arc radius [mm]	550
Installation method	directly on the spout, on the floor level, on the construction material support
Drain diameter	90

Features:

- An innovative combination of granite and steel
- Durable acrylic material that maintains its shine and color
- Only the best materials, the quality of which has been confirmed by laboratory tests
- For installation at floor level, directly on the screed or supported by construction mater
- Note! The NHC_029C and NHC_029D siphons are compatible with the shower tray.
- Hydrophobic Active-Cover coating that makes it easier for water to run off the glass
- Dedicated to Active Cover surfaces
- Double top rollers with ball bearings
- Bottom rollers allow for the door detachment and easier product care
- Safe and durable tempered glass
- Resistance to impacts, chemicals and stains in accordance with PN-EN 14428+A1:2008 norm, c
- The profile system makes it possible to reduce the curvature of the walls
- Covering of assembly elements